

Class B Steam Sterilizer

User Manual



CE 1434

Regulatory Requirements

Conformity Standards

The content of this manual is used for steam sterilizer.

Above sterilizer accords with the requirements of European Class B: 93/42/EEC

IEC 61010-1: 2010+A1:2016

IEC 61010-2-040: 2020

EN 13060: 2014 A1:2018

IEC 61326-1: 2020

RIOMAVIX SOCIEDAD LIMITADA (ES-AR-000001202)

Add.: Callede Almansa 55, 1D, Madrid 28039 Spain

Tel.: +34 658396230

E-mail: leis@riomavix.com

This product complies with the regulatory requirement of the following:

Council Directive 93/42/EEC concerning medical devices.

The CE label affixed to the product testifies compliance to the Directive.

The location of the CE marking is shown in this manual.

Certifications

Manufacturer has certified by EN ISO 13485:2016.

Original Documentation

The original document was written in English.

User Registration

You will find a nameplate at the back of machine which including the model, the Serial number and the manufacture date. Please double check the information and fill in the form of them. If you contact with your local distributor for any service, you will need these information especially the Serial number.

Model: _____

Serial Number: _____

MFG Date: _____

*The User Manual contains safety cautions and important instructions of operation.

*Please read the User Manual carefully and thoroughly in proper sequence before you start operation of the steam sterilizer.

*Please follow the instructions in the User Manual while servicing and maintaining the steam sterilizer.

*Please keep the User Manual near to the steam sterilizer for your future references.

*When Error reported during the use of the steam sterilizer, please contact your local distributor or us for our best qualified services and assistance.

Class B Steam Sterilizer

User Manual

Dear User

Welcome to use the high quality steam sterilizer manufactured by us.

Please fill in the User Registration form before using the machine.

With your record in our files, we will be able to trace the file of the machine you bought and provide you with fast and effective services.

Important Safety Instructions

Danger

To operate the steam sterilizer, pay attention to the following safety instructions given below and in the individual chapters of this User Manual.

Instruction

- Do not sterilize any tightly sealed bottles of liquids with this steam sterilizer.

Mains cable and power plug

- Never damage or change the mains cable or power plug.
- Never operate the steam sterilizer if the mains cable or power plug are damaged.

Setting up, installation, commissioning

- Only have the steam sterilizer set up, installed, and commissioned by people-authorized by Factory.
- Only operate the autoclave in area which are not subject to explosion hazards.

Preparation and sterilization of textiles and instruments

- Follow the instructions of textile and instrument manufacturers for preparing and sterilizing textiles and instruments.
- Only use wrapping materials and systems which are suitable for steam sterilization according to the manufacturer's information.

Program termination

- Take heed that when opening the door after terminating a running program, hot water steam can escape out of the chamber, depending on when the program was terminated.
- Depending on the time of the program termination, the load might not be sterile.
- Observe the clear instructions shown on the display of the steam sterilizer. If necessary, sterilize the affected objects after rewrapping.

Removal of the items to be sterilized

- Never open the door by force.
- Use a tray lifter to remove the tray. Never touch the sterilized items, the chamber or the door with unprotected hands. The parts are hot.

Maintenance

- Have the maintenance done only by authorized persons.
- Comply with the predetermined maintenance intervals.

Lifting and Carrying the autoclave

- Do not lift the door when carrying the equipment.
- Do not drag the machine while moving the equipment.
- Two people are necessary to carry the steam sterilizer.

Errors

- If repeated error message occur while operating the steam sterilizer, turn the device off.
- Only have the steam sterilizer repaired by authorized persons.

Contents

1. Description & Usage.....	1
2. Specifications.....	2
3. Installation.....	3
4. Control Panel.....	5
5. Operation.....	6
6. Door Adjustment.....	10
7. The optional function of Printer&USB.....	11
8. Maintenance & Service.....	12
9. Transportation& Storage.....	15
10. Warranty.....	15
11. Accessories.....	16
12. Recycling and disposal.....	16
13. Appendix.....	17
Working mode chart.....	17
Error code chart.....	17
Working diagram.....	18
Schematics.....	19
Piping diagram.....	20
14. Important information.....	21

1. Description & Usage

We design and manufacture the pre-vacuum steam sterilizer, especially to meet the needs for sterilization of instruments and devices in clinics, departments in the hospital and laboratories. Operators include physicians, physician's assistants and service personnel.

The Steam sterilizer has a computerized system and is user-friendly, easy to operate. The real time display shows all the data during the sterilization cycle. The software program provides auto diagnose, protection against over heating or over pressurizing, and thus ensures reliability of the sterilization results. Build-in condenser water collecting system prevents discharge of waste steam and keeps the machine clean and safe.

Steam sterilizer

The steam sterilizer uses the advanced technology of 3 times pre-vacuum and vacuum drying. It ensures the hot steam to penetrate in thin tube or porous material. The steam sterilizer is suitable for use in dentistry, ophthalmology, surgical instruments and laboratories, etc.



Fig 1-1

2. Specifications

Chamber inner dimensions (Diameter x Depth)	22L 249mm×450mm 17L 249mm×355mm
Product dimensions	625mm×440mm×475mm
Product weight	55/52Kgs
Rated voltage	120 V / 230V AC
Rated frequency	50 / 60HZ
Rated power	1800VA
Sterilizing Temperature/Pressure (Under standard atmospheric pressure)	121°C / (100-130) Kpa 134°C / (200-240) Kpa
Water tank capacity	3.5 L
Environment temperature	+5°C~+40°C
Relative Humidity Range	30%~75%
Overtoltage Category	II
Pollution Degree of the intended environment	2

Note:

The Sterilizing Temperature/Pressure means the chamber temperature and pressure during the phase of sterilization. The value varies under different atmospheric pressure.

The highest temperature location is at the top of steam injection port and the lowest temperature is at the bottom near the door.

Figures

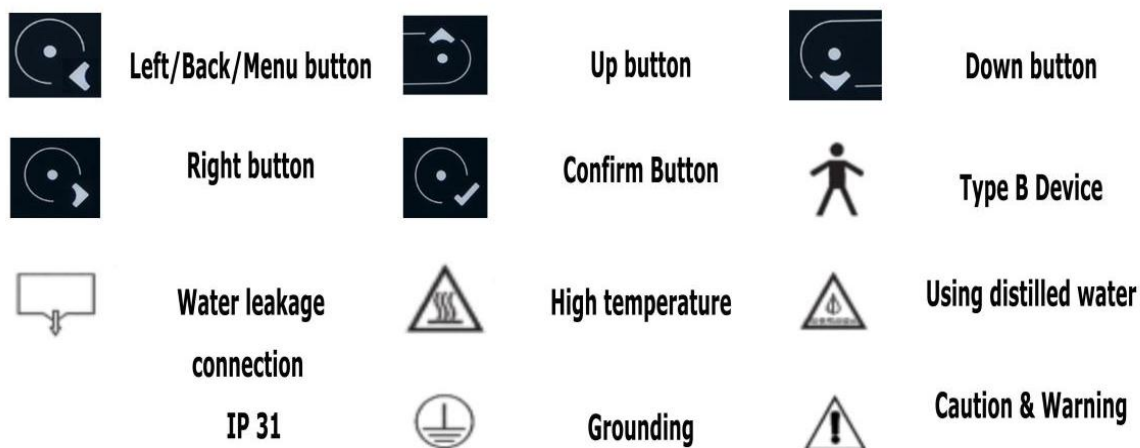

Tip:

Standard atmospheric pressure: It is the atmospheric pressure at sea level. It refers to 1 Standard atmospheric pressure.

The value is 0.1MPa =1000 hPa =1.0 Bar. Atmospheric pressure decreases by higher altitude.

For instance: At 3000meters or lower, per increase of altitude of 1000 meters will result in a decrease of Atmospheric pressure by 0.1 Bar approximately.

3. Installation

The steam sterilizer should be installed in a drafty place allowing minimum 10 cm space at all sides and 20 cm at the top. The radiation openings at the side of the machine should not be blocked. The steam sterilizer should be placed on a leveled counter top.(Fig 3-1)

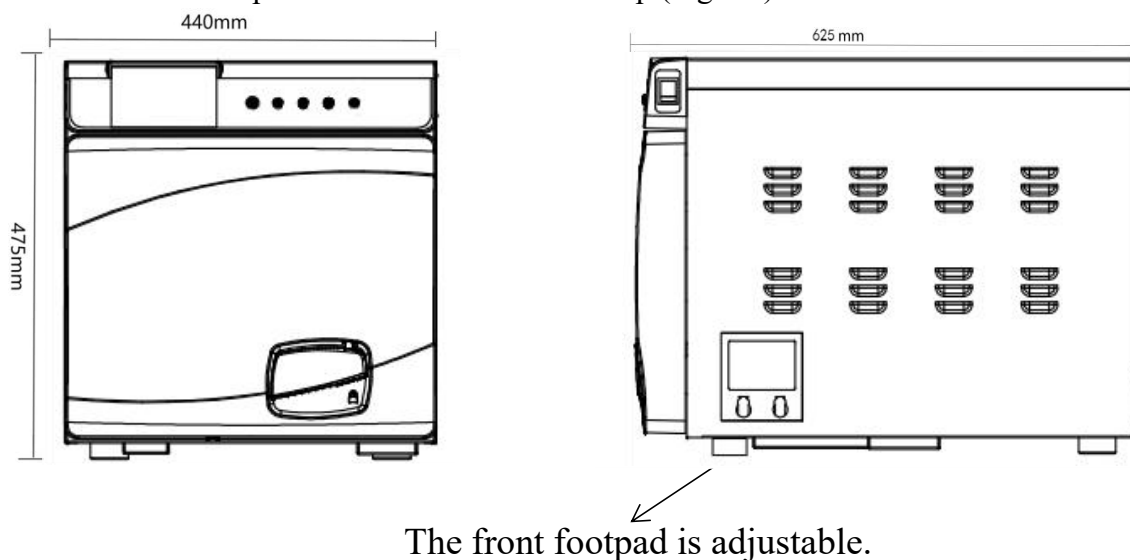

Fig 3-1



Caution:

If the front of the machine is low and the rear is high, it will affect the drainage and final drying effect. Please pay attention to properly raise the front foot of the machine.

Preparation

We have installed draining filter in the chamber. You should clean the draining filter after using the steam sterilizer for a long time. The below instruction shows you how to clean it.



Fig 3-2



Fig 3-3

Before turn on the power, please make sure using the mains cable come with the package. Ensure the socket that the mains cable is connected to is properly grounded.



Fig 3-4

1. Turn on the power, the self-testing result will be shown as Fig3-5. If the pressure value is more than 10Kpa, you should do the PRESSURE CORRECTION. In the set up, enter the password (777777) for the PRESSURE CORRECTION.

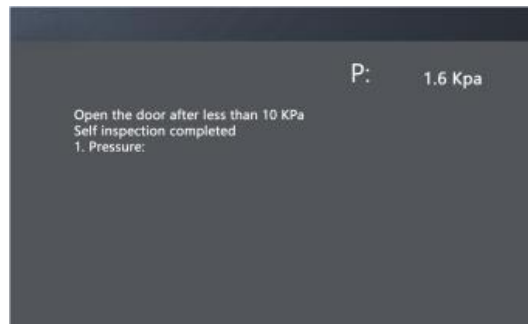

Fig 3-5

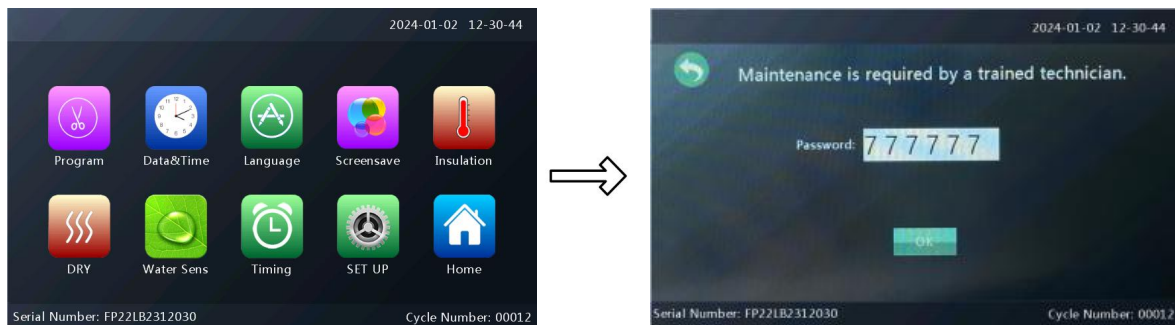

Fig 3-6

2. Enter the PRESSURE CORRECTION, the Fig 3-7 will be displayed. After the auto-calibration, you can input the local sea level and press the confirm button  to start the operation of the sterilization.



Fig 3-7



Caution:

The power supply must be able to afford 1800VA and grounded correctly.

4. Control Panel

1. Display



1. Cycle name
2. Logo
3. Working diagram
4. Working status
5. Pressure
6. Current temperature
7. Date
8. Total time
9. The time of current step
10. Other ICON

Fig 4-1



Lock



Unlock



USB Connected



USB Not Connected



Clean Water Tank Full



Clean Water Tank Empty



Correct Cycle Ending



Operation Error



Used Water Tank Empty



Used Water Tank Full



Caution



Timing Function On



Standard Water Quality



Water quality Sensor Closed



Poor Water Quality

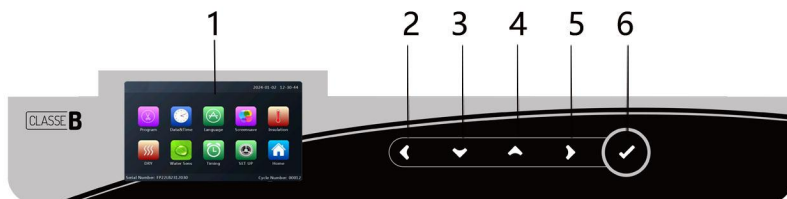

2. Left/ Back / Menu /Select button

When you press the left button, it will enter into the main menu directly. You can press the select button to choose the program. You can press this left button to back into last Interface.

3. Up button

When the Menu of program is displayed, the select button operates as an 'Up' button.

4. Down button

When the Menu of program is displayed, the select button operates as an 'Down' button.

5. Right button

Press the right button to confirm the sterilization program you choose or set up. If you have to stop the running cycle immediately, you should keep pressing this button for 5 seconds. When you see 'cancel', please press Confirm button again, then the cycle will be canceled.

6. Confirm /OK button

Press the OK button to start program when you choose or confirm the program.

5. Operation

Please connect the power supply correctly first, and turn on the power switch on the right side of the steam sterilizer. When the light of the switch is on, it means the power for the machine to work is enough. The display will be blank and the system will be in Self-test. The self-test will take 10 Seconds, and then the steam sterilizer will be in standby mode.

5.1 Filling water

If the water level is lower than the lowest level the system will remind you filling water with alarming sounds. Then you can open the tank lid at the top of the sterilizer to fill the water. The minimum water charge in the water reservoir is 400ml. But the minimum remind level is 750ml when the water tank is empty.

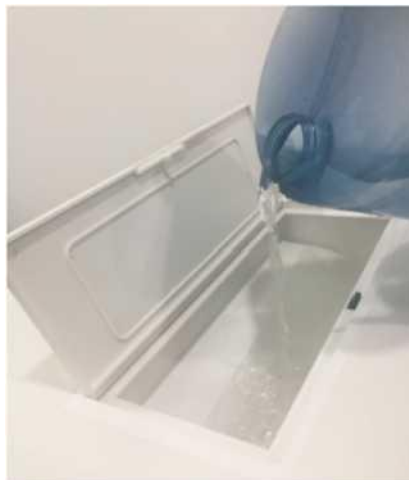

Fig 5-1



Caution:

1. Be sure to use distilled water.
2. Do not slant the sterilizer when there is clean water in the tank.
3. Always drain the used water tank after daily operation.

5.2 Working cycle

Turn on the power, the system will enter into self-test mode directly, and the test result will be shown as fig 5-3.



Fig 5-2

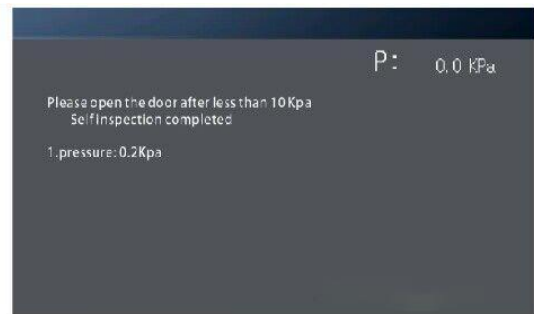

Fig 5-3

Press the Left button , you will see the display as Fig 5-4.



Fig 5-4



Then press the confirm button , different cycles will be shown as left Fig 5-5. Press the up or down button to select the cycle, and the confirm button to into the cycle as right Fig 5-5 shows. Pressing Right button  for 3 seconds, you will see the indication 'Start?'. Then you can press confirm button  to start the cycle.



Fig 5-5

Press the Right button  for 3 seconds to set the custom sterilization. Press the Right button to set the temperature, vacuum times, the sterilization and the drying time.



Fig 5-6

When you are at the interface of Fig 5-7, you can press the button to choose the parameters. Then press the Confirm button to save the settings.

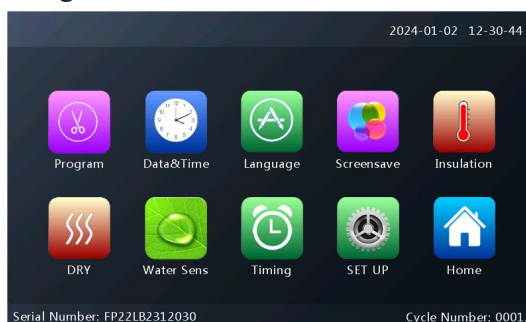

Fig 5-7

Fig 5-8 the Technical setting interface is forbidden for the users to use. It is intended only for the professional technicians authorized by your supplier.



Fig 5-8



Caution:

The instruments to be sterilized should be placed in the trays without touching each other, allowing room for steam to pass through. It is suggested to using the tray holder to put the tray with the instruments inside the chamber to avoid scalding.

5.3 End of the sterilization

At the end of the sterilization, the display will show 'Open the door' to remind you with alarm sound. Then you can open the door and unload the instruments from chamber by tray holder.

If you are not using the steam sterilizer for a long while, please remember to turn the main power switch off or unplug the power cord.



Caution:

Do not open the door till the pressure is less than 9 kPa.

The instrument rack should be put inside the chamber as the following Fig 9-12.

The first way (Fig 5-9, Fig 5-10):



Fig 5-9

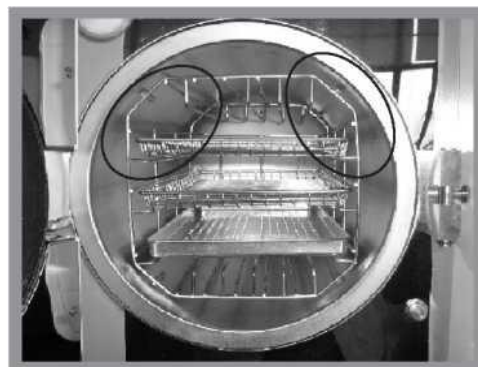

Fig 5-10

The second way: clockwise rotate the instrument rack by 90°, based on the first way (Fig 5-11, Fig 5-12).



Fig 5-11

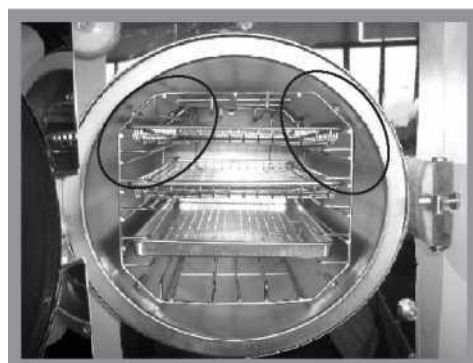

Fig 5-12

Notes: the circle stamped angle is up along.

6. Door Adjustment

Under normal circumstances, the door does not need to be adjusted separately. If you find that the door is leaking (i.e. the seal is unreliable), you can adjust the sealing cap according to the method showed below.

6.1 Open the door.

6.2 Rotate the hidden Philip's head screw ❶ counterclockwise. Pull down ❶ to ❷ position and turn the sealing cap clockwise to tighten the door.

6.3 Adjust the germ holder to be well sealed.

If the door is closed too tightly, you can turn the sealing cap counterclockwise to loosen. The adjustment should be under the premise of ensuring the reliable sealing of the machine. And please make sure to tighten the screw after the adjustment.

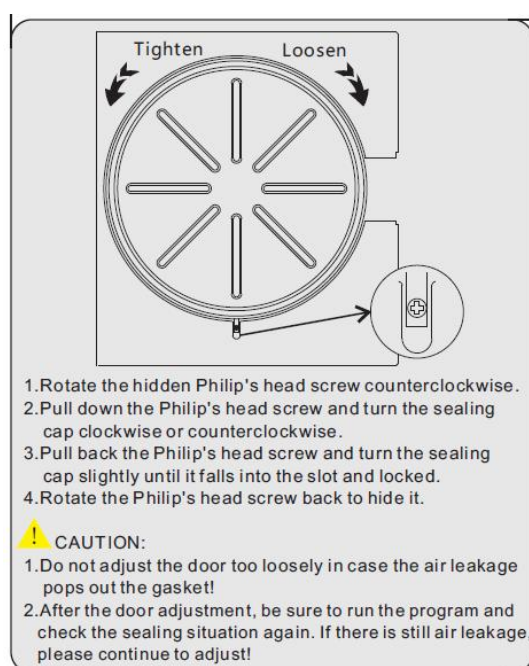
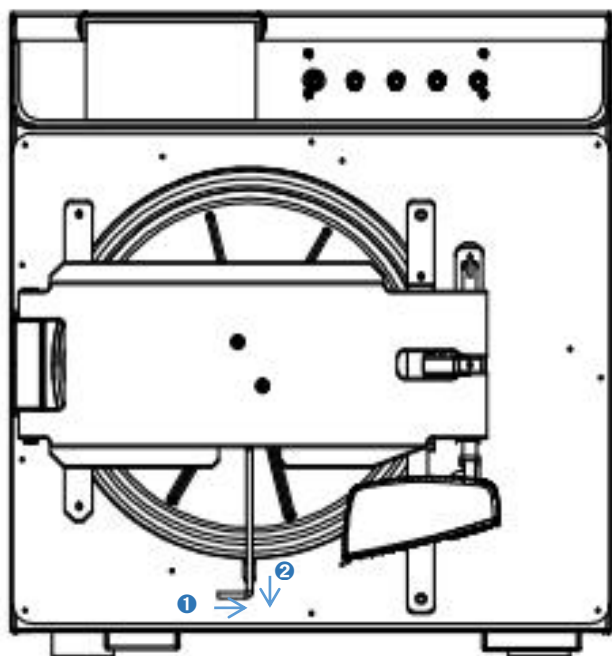

Caution:

Do not to adjust the door if the door is closed. When adjusting the door, you should not touch the sealing lid to avoid burns. Please do the adjustment til the door is cool down.

7. Printer and USB

7.1 The Printer

Steam sterilizer have upgraded to a built-in printer based on customer demand(Fig 6-1).

The printed results are shown as Fig 6-2.



Fig 6-1

```

SN:FM08LB1901001
COUNTER: 00009
ST. Type: B
UNIVERSAL CLASS B
STRE.TEMP: 134 ° C
STRE.PRES: 204 KPa
ST. TIME: 4 MIN
DRY TIME: 10 MIN
START DATE: 2022-11-24
START TIME: 15:04:22
STAGE PRESS TEMP TIME
      KPa ° C M:S
START 0 20.8 00:00
VAC.1 - 82 30.2 05:59
PRE.1 49 107.0 09:46
VAC.2 - 82 68.9 11:58
PRE.2 49 110.0 13:25
VAC.3 - 82 80.6 15:25
HEAT. 209 135.0 19:33
ST.BE 209 135.0 19:33
ST.NE 208 135.3 23:35
DRYBE 9 117.0 24:25
DRYEN - 81 96.7 34:25
END 0 102.8 35:00
==PROGAM COMPLETED==
END TIME: 15:39:24
PRES.MAX: 213 kPa
PRES.MIN: 197 kPa
TEMP.MAX: 135.9 ° C
TEMP.MIN: 135.0 ° C
OPERATOR:
    
```

7.2 USB module function

7.2.1 Main function:

- Storage of printed data of sterilization
- Built-in FLASH memorizer
- U-disk Download

7.2.2 Operation instruction:

- ① The USB port and printer interface are normally open and automatically activated when the USB port is plugged in.
- ② Insert the USB flash into the USB port before starting the cycle (The gray USB icon on the screen will turn green).
- ③ In the history, you can copy the sterilization result to the USB.



Caution:

Our steam sterilizer only can be compatible with the printer provided by us. And the printer function is optional.

8. Maintenance and Service

8.1 How to clean the water tank

8.1.1 Please clean the clean water tank and the waste water tank regularly.

The process is following:

- 1) Empty the clean water tank , please refer to item 8.2 draining the water.
- 2) Click the 'PRESS' area on the top tank lid, then the switch of tank lid will be open directly as fig7-1 indication.
- 3) You can start to clean the tank. Use cotton to dip in some alcohol or medical disinfectant to scour the tank wall and wash it by distilled water. Then empty and dry the tank. After it you should take out the filter net for cleaning.

As fig 8-2 indication,

- 4) After cleaning the tank, assemble water filter and close the tank cover.
- 5) After the cleaning, you can add distilled water to start operation.

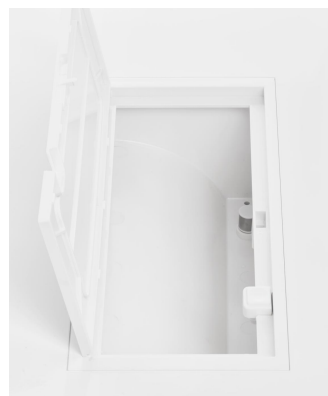

Fig 8-1

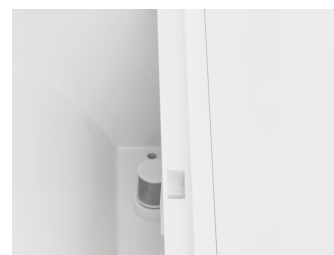

Fig 8-2

8.2 Drainage method

How to drain the clean water and waste water tanks:

Insert the supplied drain tube into the drain port as shown in Figure 8-3 to drain.



Fig 8-3



Caution:

All the above maintenance must be disconnected from the power supply and cooled sufficiently before operation!

Use qualified distilled water, items placed in the tray should be clean.

For items with other impurities, it is recommended that you pack and seal them in special bags. Always keep the sterilizer clean.

8.3 Drainage filter cleaning

After a long time usage, some small impurities maybe deposit on the drain filter, which will affect vacuum and drying. All the impurities comes from the oil, dirt or dust of the instruments which need sterilization, or it may come from the water. In order to prolong the life of the drain filter, clean the water filter monthly with a soft brush.

Screw off the nut before you take off the draining filter. After cleaning the filter, then install it back in chamber with its top nut.

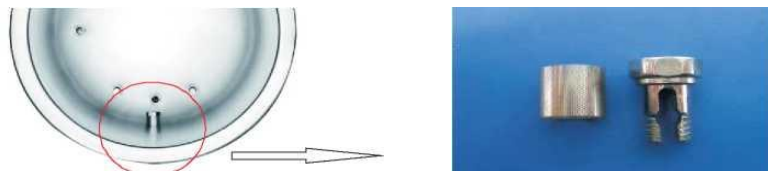

Fig 8-4

8.4 Clean the seal plate periodically

After a period of use, the sealing gland may accumulate some scale, which will cause leakage. You should clean the sealing gland regularly. You can use a soft cloth soaked with distilled water to wipe the rubber seal and the sealing gland (Fig 8-6 & 8-7). If it is still leaking, you may need to take the rubber seal out for cleaning. If the seal is broken, you need to replace it with a new one.



Fig 8-6



Fig 8-7

8.5 Replace the door gasket

You will need a flat screw driver without a sharp tip. Pay attention about head of the flat screw driver. The install step according to Fig8-8.



Fig 8-8

- 1) Hold the edge of the door gasket with one hand and insert the screw driver beneath the seal with your other hand and then pull out the seal slowly.
- 2) Once a section of the gasket is out, you may pull the whole gasket out slowly with both of your hands. You can now clean the gasket groove and the gasket. If the gasket is broken or damaged, you must replace it with a new one.
- 3) After the groove and the gasket are cleaned, you may remount the gasket back in place.
Caution: The door gasket should be mounted evenly inside the groove with first 4 positioning points in place. You may use your hand to press the gasket in place evenly.
- 4) **Attention:** When inserting the gasket, the inner edge might evaginate. You may use a screw driver to press the edge down in the groove.



Caution:

Turn off the power and let it cool down before you replace the door gasket, which could avoid any burning injuries.

8.6 Automatic Cleaning Procedure

When the steam sterilizer has been used more than 300 cycles, the system will remind you to do the cleaning cycle automatically.

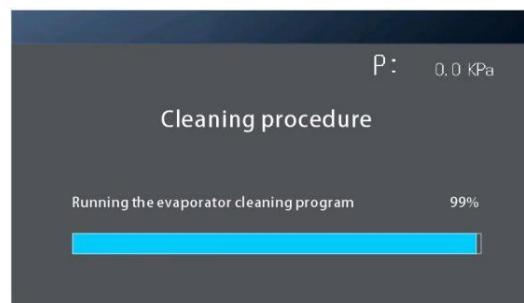
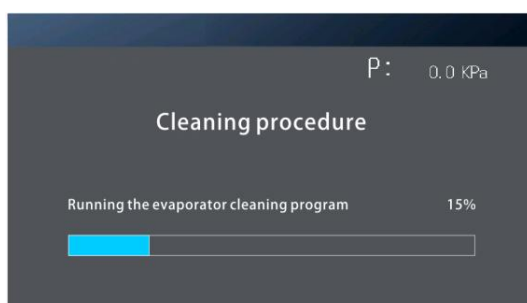

Please make sure the clean water tank is full and the door is closed before running cleaning procedure. The cleaning cycle can be completed in 15-20minutes. You should turn off the power and restart the unit after the cycle is completed.

9. Transportation and Storage

9.1 Preparation for transportation and storage

Power the machine off, unplug the power cord and cool down the chamber.

9.2 The steam sterilizer should be transported and stored in the follow conditions:

Temperature: -40 ~ +55 °C

Humidity: < 85%

Atmospheric pressure: 500Hpa ~ 1060 Hpa

9.3 Package

Package is used in transportation for protecting product, conveniently delivery and sales. The sterilizer package requirement should be as followed:

- 1) Product can not over 3/4 volume of package.
- 2) Product should be fix inside the package.
- 3) Package bag should be higher than product 6mm.

Caution: Do not drag the machine while moving.

10. Warranty

The manufacturer provides a warranty for repair at not change to the customer for one year after the date of Bill of Lading.

Following are the disclaimers:

- 10.1 Damage due to improper moving, installing and operating the machine.
- 10.2 Damage due to dismantling the machine by unauthorized personal.
- 10.3 Do not have guarantee of end user.
- 10.4 Inappropriate operation on the machine without following the operator's manual.
- 10.5 Damage caused by power surge, fire or other external matters.

11. Accessories

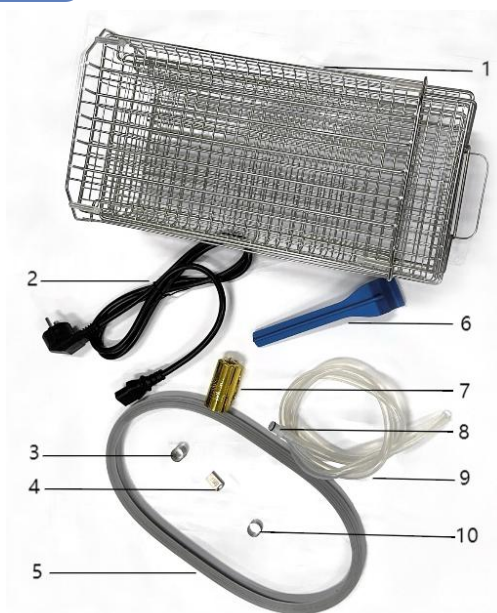

No.	Description	Qty.	No.	Description	Qty.
1	Tray rack and tray	1/3	6	Tray holder	1
2	Power cord	1	7	Print paper	1
3	Water filter net	1	8	Drainage joint	2
4	USB disk	1	9	Water outlet tube	1
5	Door gasket	1	10	Draining filter net	1

12. Recycling and Disposal



The steam sterilizers are mainly built from fiber-reinforced polymers, metals and electronic components.

In case of disposal:

- Separate the various components according to the materials they are made of.
- Drop the sterilizer with a company that specializes on the recycling of related products.
- Do not abandon the sterilizer in unsecured places.
- Always refer to current / applicable laws and rules in the country of use.

The same instructions apply to disposal of all used consumable parts.

13. Appendix

Form 1: Working mode

	134 B	134 S	134 B	121 B	121 S	Customized	BD-Helix	Leak Test
Sterilizing temperature	134	134	134	121	121	121/134	134	—
Sterilizing pressure	2.10	2.10	2.10	1.10	1.10	1.10/2.10	2.10	—
Class	B	S	B	B	S	S / B	B	—
Pre-heating	0-7 min	0-7 min	0-7 min	0-7 min	0-7 min	0-7 min	0-7 min	—
Vacuum times	3 times	1 time	3 times	3 times	1 time	1/3 times	3 times	4min
Sterilizing time	4min	4min	20min	20min	20min	4-60min	3.5min	Keep pressure 10min
Drying time	10min	10min	10min	20min	9min	4-60min	2min	—
Total approx.time	35min	25min	45min	55min	40min	/	20min	18min

Form 2: Error code

Item	Error code	Description	Solution
1	E01	Steam injection error	Contact with your supplier
2	E02	Pressure out of set range during sterilization	Contact with your supplier
3	E03	Door loose in cycle	Contact with your supplier
4	E04	Pressure leakage/ Overload	Contact with your supplier
5	E05	V1/ V2 solenoid valve blocked	Contact with your supplier
6	E06	Failed to vacuum	Contact with your supplier
7	E09	Steam generator damaged	Contact with your supplier
8	E10	Heating ring preheat speed slow	Contact with your supplier
9	E11	Temperature out of set range during sterilization	Contact with your supplier
10	E12	Temperature do not reach set range during	Contact with your supplier
11	E27	Excessive leakage	Contact with your supplier
12	E31	Inner chamber temperature out of set range	Contact with your supplier
13	E32	Steam generator temperature out of set range	Contact with your supplier
14	E33	Chamber temperature out of set range	Contact with your supplier
15	E41	Inner chamber temperature sensor damaged	Contact with your supplier
16	E42	Steam generator temperature sensor damaged	Contact with your supplier
17	E43	Chamber temperature sensor damaged	Contact with your supplier
18	E51	Poor contact inner chamber temperature sensor	Contact with your supplier
19	E52	Poor contact steam generator temperature sensor	Contact with your supplier
20	E53	Poor contact chamber temperature sensor	Contact with your supplier

Form 3: Working diagram

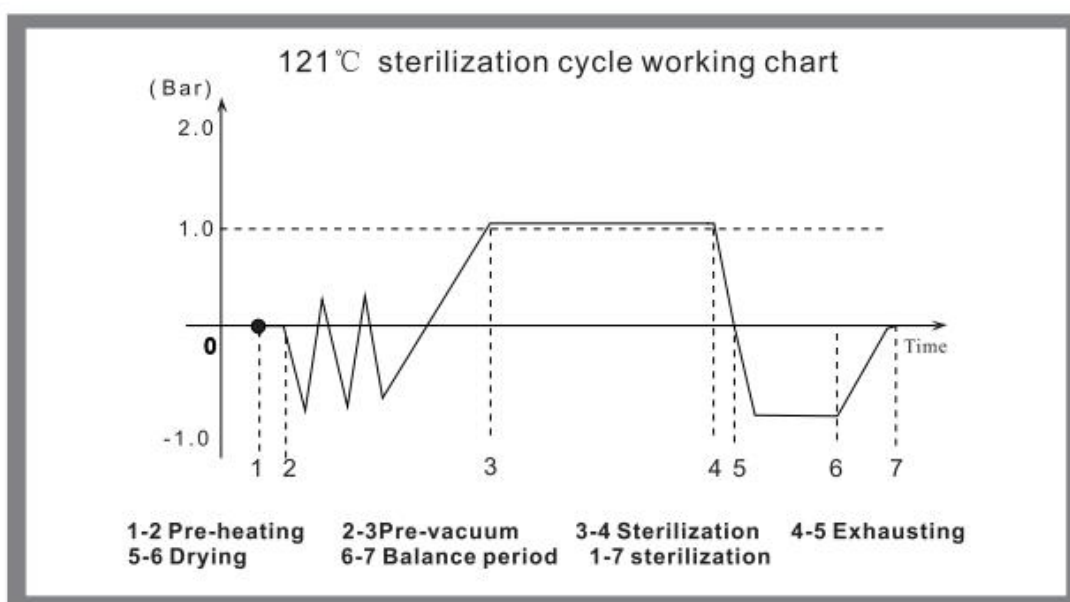
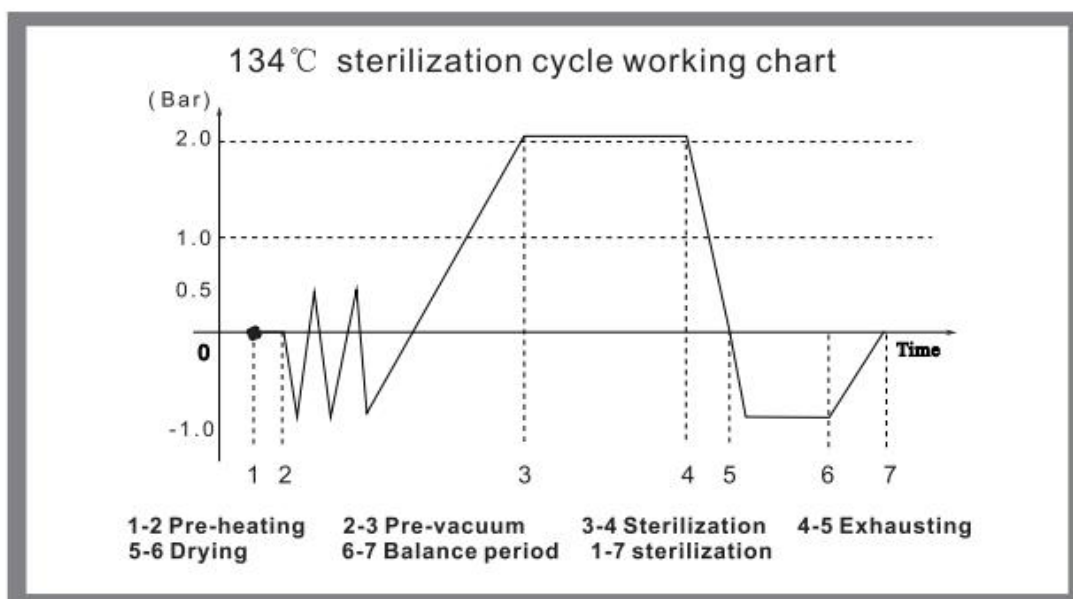

Form 4: Schematics

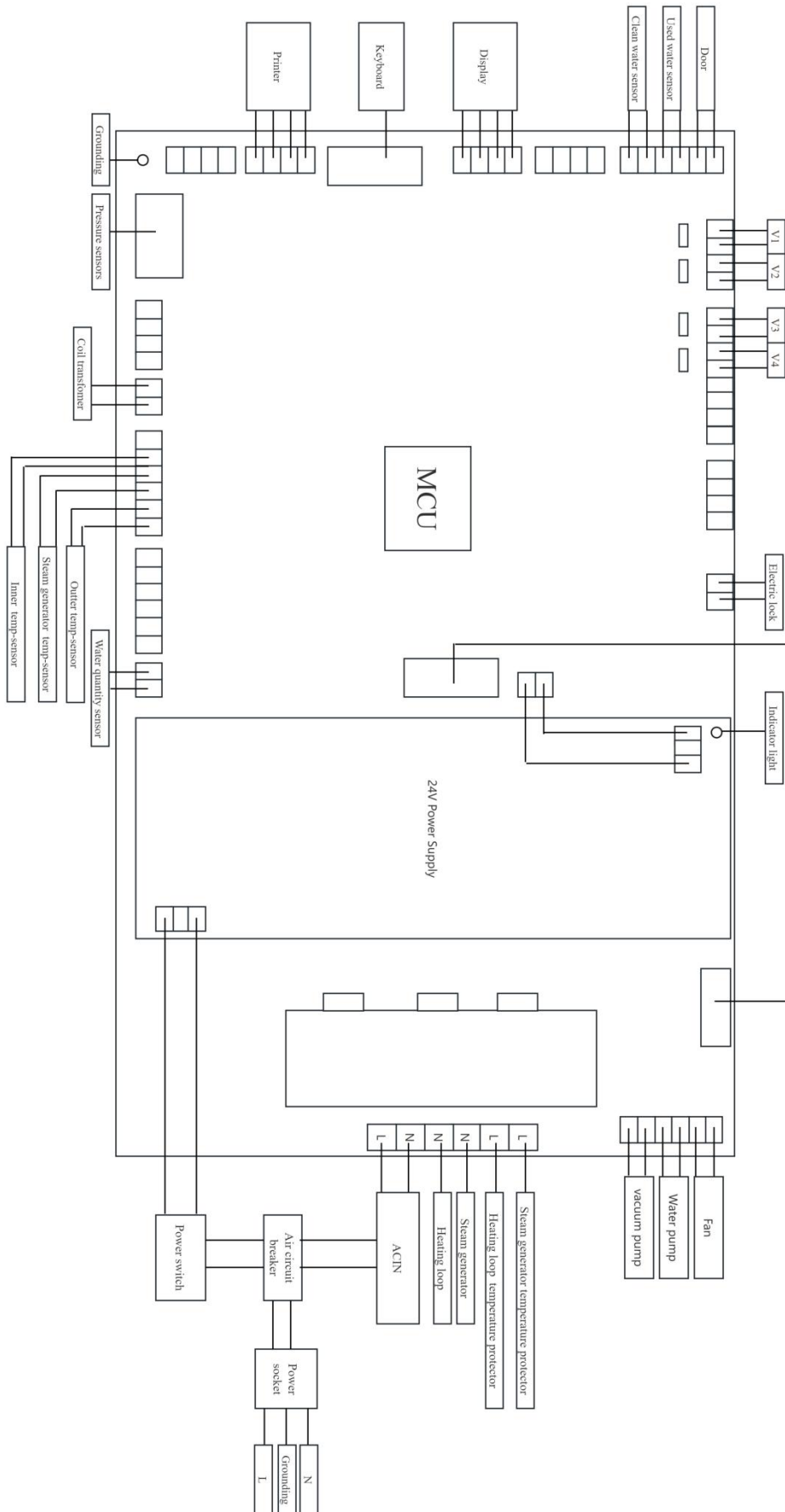

Form 5: Piping diagram

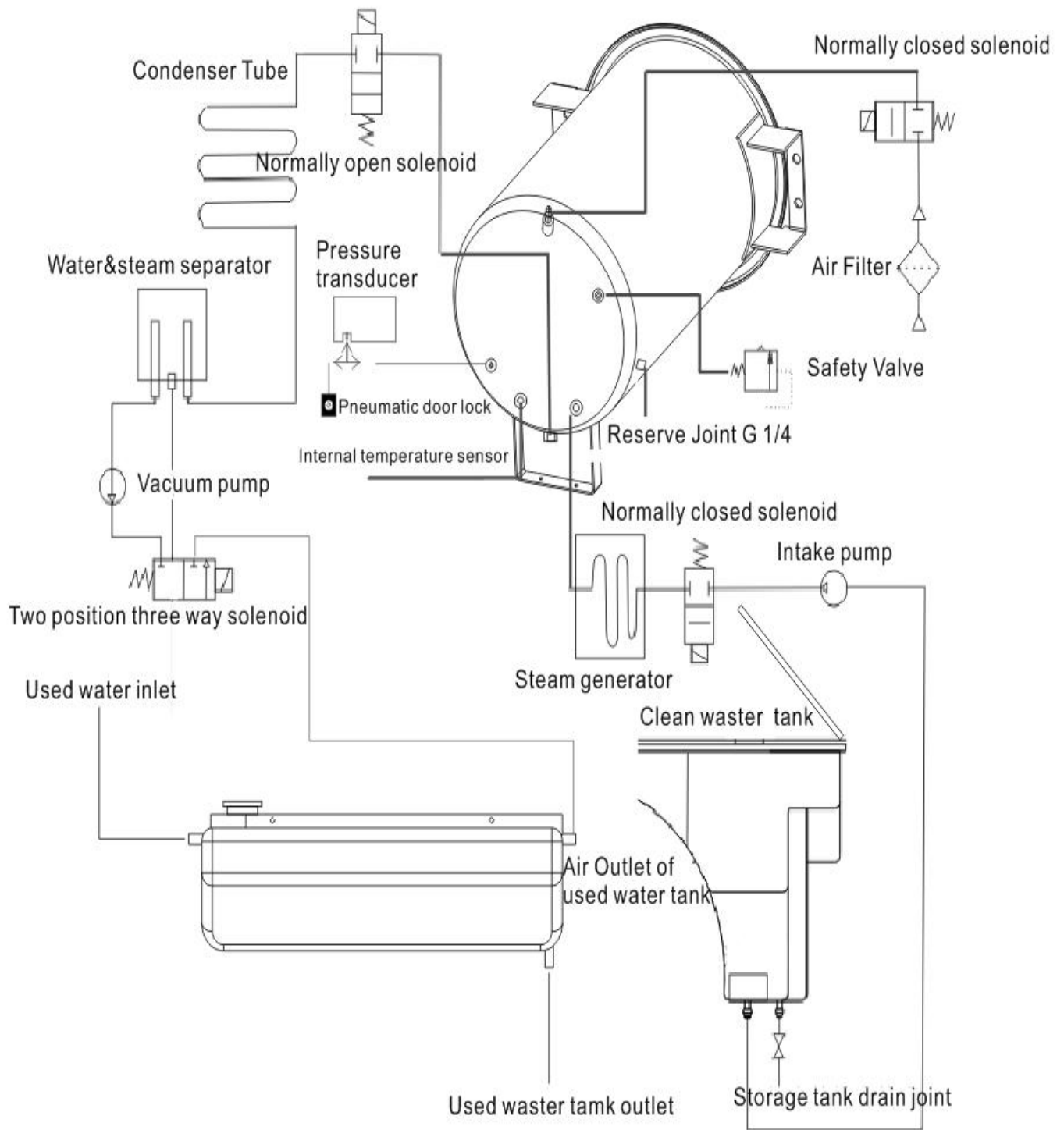

14. Important Information

1. The autoclave must be installed on a leveled counter top.
2. If the altitude at using location exceeds 500 meters, please run the automatic altitude calibration program before use, or contact your supplier for altitude calibration.
3. Distilled water must be used to prolong the life of the machine.
4. The radiation openings in the machine must not be blocked or covered.
5. Instruments should be placed on the tray allowing space between one another and thus allowing steam to pass through.
6. Chamber door knob must be turned to its locking position.
7. Never try to open the chamber door before pressure displays '0.0'.
8. To avoid burning injuries, power off the machine and let it cool down before replacing the seal.
9. No dragging while the machine is moving.
10. Power connection must be grounded properly. Must be provided enough power (1800VA).
11. If any abnormal situation or sudden accident, please make sure switching off the power immediately and stay away from the equipment.
12. This machine is not recommended for use above 3000m altitude. Please contact us if you use this machine.